

摇摆活塞式气泵 Wob-Piston Pumps for Gas

WPA90V

特点 Features

无油润滑 Oil-Free

低功耗 High efficiency

免维护 Maintenance Free

重量轻 Aluminum pump head

无污染 Uncontaminated transfer

结构紧凑 Compact size

长寿命 Long life

低噪音低振动 Low noise level&vibration

高效风冷 High efficiency air cooling

交流电机 AC220/110V

应用 Typical Applications

医疗设备 Medical devices

过滤与雾化 Filtration and nebulization

压缩空气供应 Compressed air supply

实验室设备 Lab equipment

包装设备 Packaging equipment

分析仪器 Analytical equipment

喷绘打印 Wide-Format Printer

真空吸取 Vacuum transfer

美容设备 Beauty equipment

食品行业 Food Industry

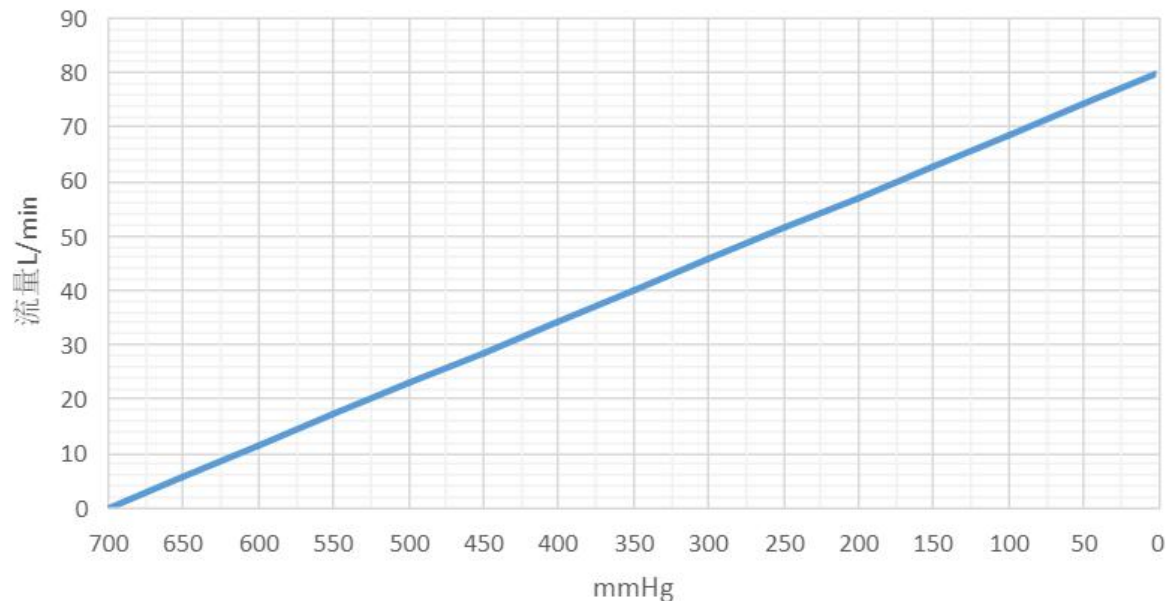

技术参数 Technical Data

额定电压 Rated voltage	AC220V 50Hz	AC110V 60Hz
功率 Power	250W	250W
电容 Capacitor	12uF	20uF
转速 Speed	1425rpm	1750rpm
空载流量 Free flowing	80L/M	90L/M
最大真空度 Max. vacuum	700mmHg	700mmHg
使用温度 Ambient temperature	0-40℃	0-40℃
重量 Weight	8.35Kg	8.35Kg

外形尺寸: Dimensions(mm)

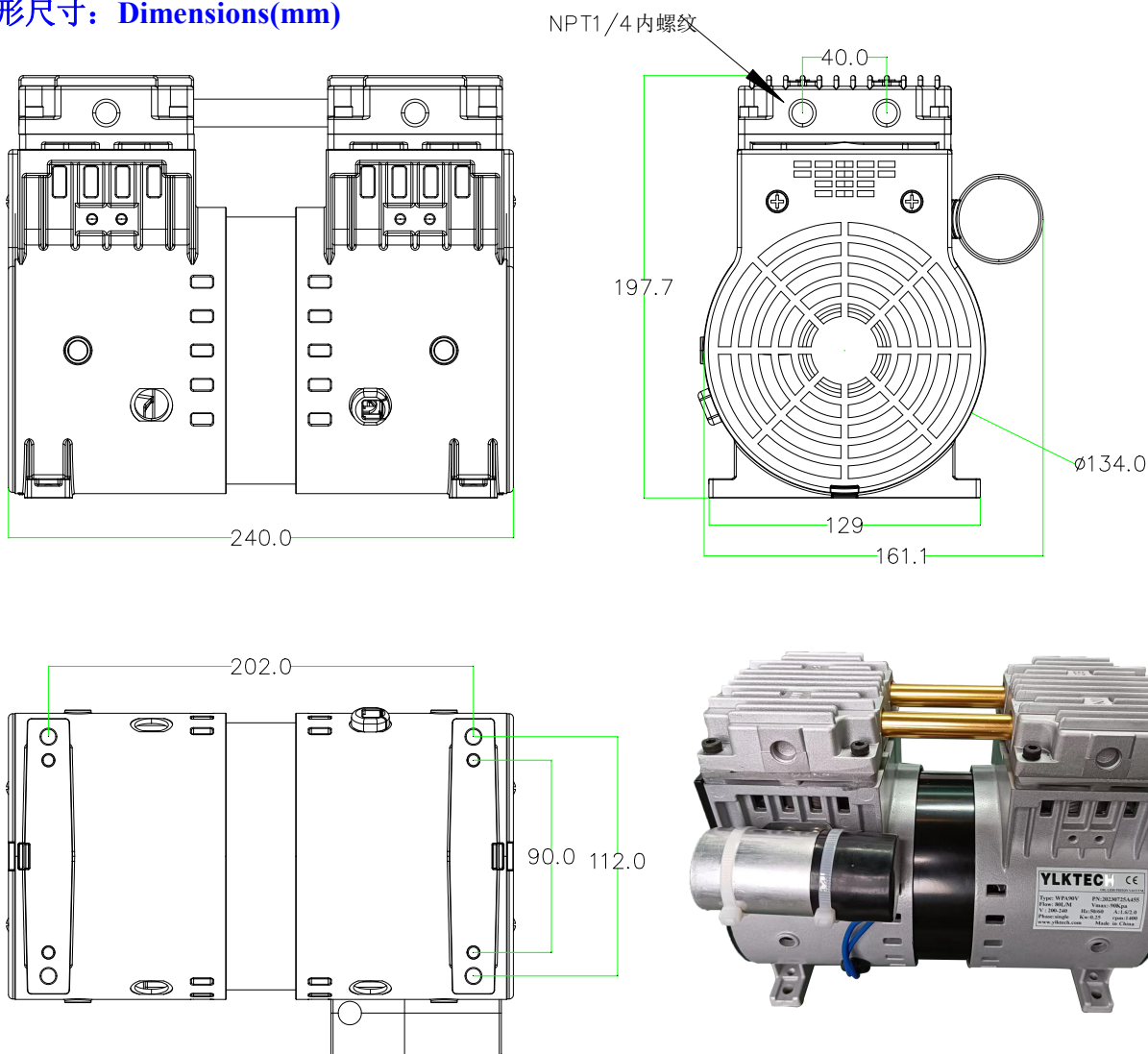

可根据客户使用要求定做: We can design according to customer requirements