

## 摇摆活塞式气泵 Wob-Piston Pumps for Gas

### WPA200V

#### 特点 Features

无油润滑 Oil-Free

低功耗 High efficiency

免维护 Maintenance Free

重量轻 Aluminum pump head

无污染 Uncontaminated transfer

结构紧凑 Compact size

长寿命 Long life

低噪音低振动 Low noise level&vibration

高效风冷 High efficiency air cooling

交流电机 AC220/110V

#### 应用 Typical Applications

医疗设备 Medical devices

过滤与雾化 Filtration and nebulization

压缩空气供应 Compressed air supply

实验室设备 Lab equipment

包装设备 Packaging equipment

分析仪器 Analytical equipment

喷绘打印 Wide-Format Printer

真空吸取 Vacuum transfer

美容设备 Beauty equipment

食品行业 Food Industry

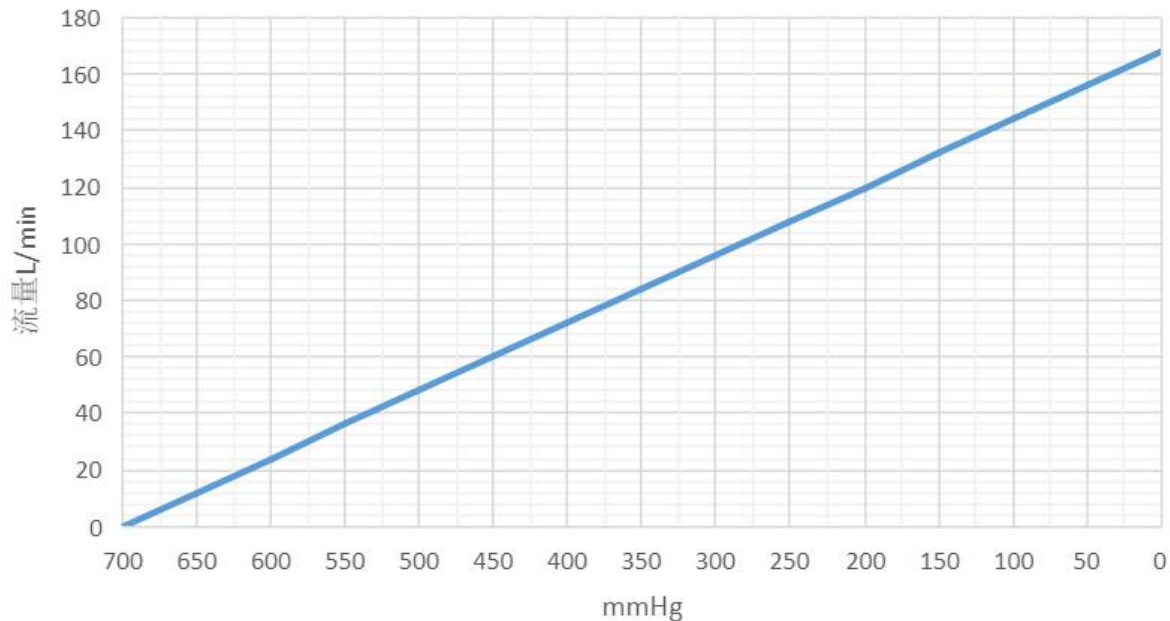

### 技术参数 Technical Data

额定电压 Rated voltage	AC220V 50Hz	AC110V 60Hz
功率 Power	560W	560W
电容 Capacitor	12uF	20uF
转速 Speed	1425rpm	1750rpm
空载流量 Free flowing	165L/M	198L/M
最大真空度 Max. vacuum	700mmHg	700mmHg
使用温度 Ambient temperature	0-40°C	0-40°C
重量 Weight	11.5Kg	11.5Kg

### 外形尺寸: Dimensions(mm)

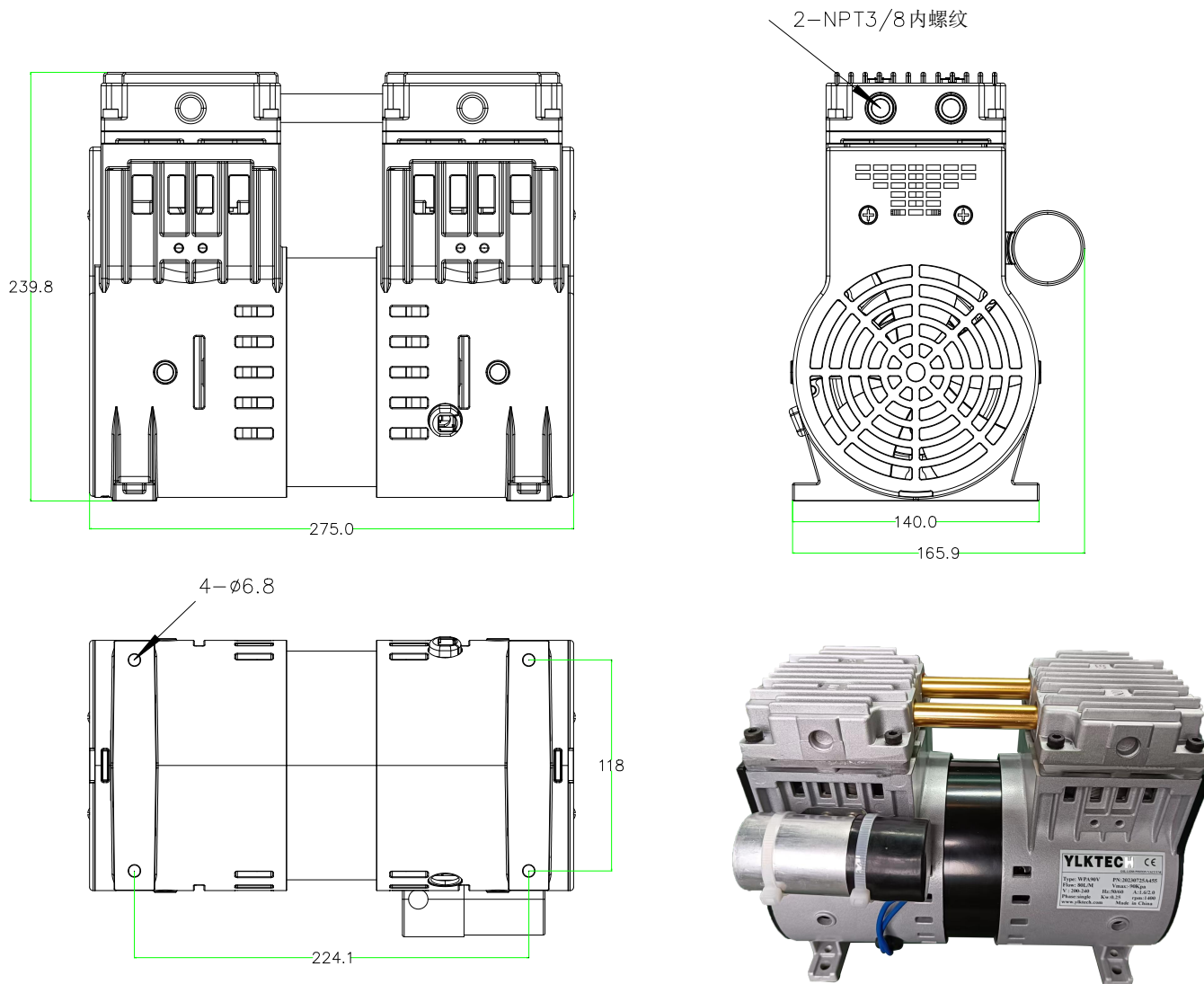

可根据客户使用要求定做: We can design according to customer requirements